

Article number: 20195V30502SW

Description: E+G double T-angel clamps
GN 195-V30-50-2-SW

Measures

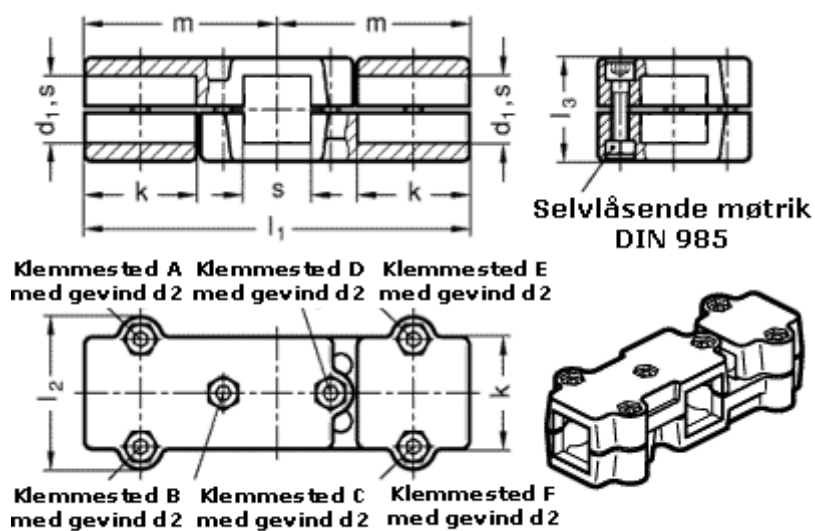

d2 = M8

k = 50

l1 = 172

l2 = 68

l3 = 46

m = 86

s = V 30